

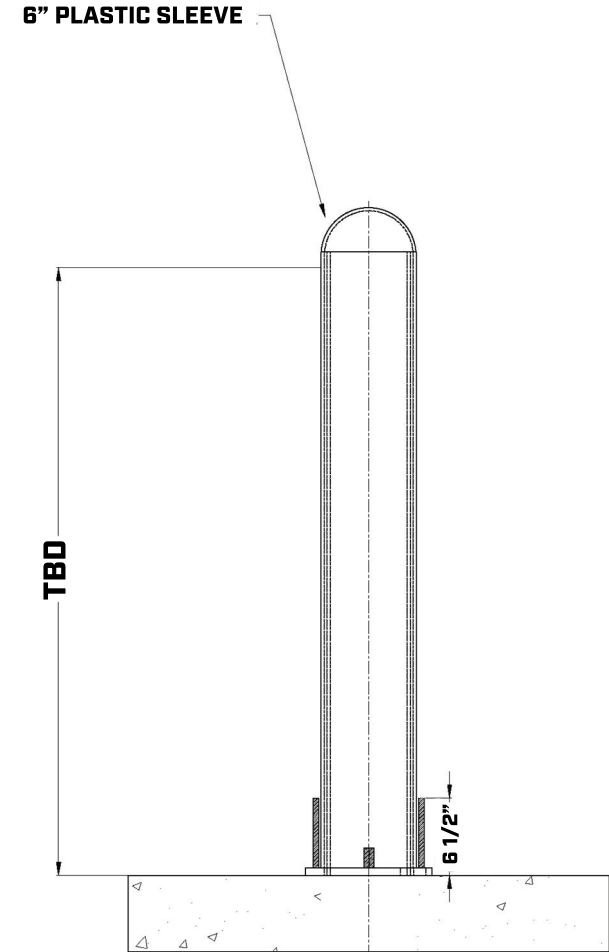

6" COLLAPSIBLE LOCKING BOLLARD

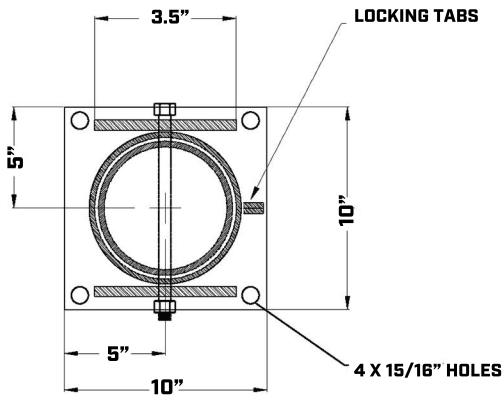
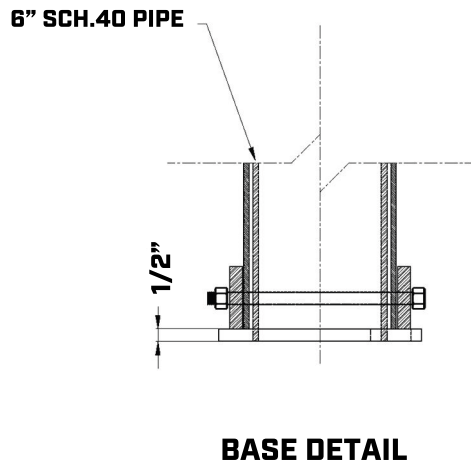

Company: _____
Project: _____
Name: _____

Phone #: _____
Email : _____
Address: _____